

## Dynamic Response of Machine Foundation Resting on End Bearing Piles

Mohammed Y. Fattah<sup>1</sup>, Mohammed J. Hamood<sup>2</sup>, and Ibtihal A. M. Al-Nakdy<sup>3</sup>

<sup>1</sup> Professor, Building and Construction Engineering Department, University of Technology, Baghdad, Iraq.  
e-mail: myf\_1968@yahoo.com.

<sup>2</sup> Assist. Professor, Building and Construction Engineering Department, University of Technology, Baghdad, Iraq.

<sup>3</sup> Chief engineer, Ministry of Education.

**Keywords:** Dynamic, finite elements, machine foundation, pile.

**Abstract.** Machine foundations are unique, because they may be subjected to significant dynamic loads during operation in addition to normal design loads of gravity, wind, and earthquake. The magnitude and characteristics of the operating loads depend on the type, size, speed, and layout of the machine. The foundation has to guarantee smooth running during normal operation, and foundation integrity for possible accidental loading situations. Dynamic effects of the machines play a major role on sizing of the foundation where conditions, like resonance is avoided by varying the stiffness and the mass of the structure which leads to modifications in foundation sizes. For carrying out these studies, a detailed 3D finite element analysis approach is considered.

Herein, a finite element software (ANSYS.11) is adopted which provides an efficient tool for dynamic analysis and structural design of machine foundations. As a case study, piled machine foundation in sandy soil is analyzed. Machine foundations resting on end bearing piles are introduced. Harmonic dynamic load is chosen. A parametric study is carried out to investigate the effect of several parameters including: geometry of the piled machine foundation, the amplitude of the dynamic load, frequency of the dynamic load and damping ratio. Linear elastic model is adopted for modeling the piles and their cap for machine foundation using eight node isoparametric (solid 65) element, while elastic model is adopted to model the soil behavior and eight node isoparametric elements are used to model the soil through (solid 45) element.

It is concluded that the frequency ratio decreases with increase of spacing values due to increase in natural frequency, except in the case of 3 m spacing where it increases due to decrease in natural frequency as the mass was increased obviously. The increase in spacing caused the increase of natural frequency by about 6% in the case of 1.5 m spacing more than the 1.25 m case and by about 3% for the 1.75 m spacing more than the 1.5 m reference case.

The increase in pile cap length caused the natural frequency to decrease by about 18% for the 3.75 m pile cap length as compared with the reference case and by 29% in the case of 5 m less than the reference case. In the case of increasing pile cap thickness, there was only a slight difference in the values of natural frequency.

### 1 INTRODUCTION

The design of foundations and structures subjected to vibratory loads is considered to be a complex process presenting problems involving structural and geotechnical engineering and the theory of vibration. The structural form of a machine foundation is generally determined by the information provided by the geotechnical consultant and the machine's manufacturer.

There are aspects that should be taken into account in the criteria for satisfactory action of a block foundation under dynamic load:

1. There should be no resonance. The frequency ratio (defined as the ratio of operating frequency to natural frequency) should be either less than 0.5 or more than 2 for important machines (Rao, 2011).
2. The amplitudes of motion at operating frequencies should not exceed the limiting amplitudes (Prakash and Puri, 2006).
3. The vibrations must not be annoying to the persons working in the shops or damping to the other precision machines (Prakash and Puri, 2006).
4. Foundation block should be structurally adequate to carry the loads (Rao, 2011).
5. The combined center of gravity of machine and foundation and the center of contact area (with the soil) should lie on the same vertical line as far as possible (Rao, 2011), so that the bearing capacity of all the system will increase.

**Mohammed Y. Fattah, Mohammed J. Hamood, and Ibtihal A. M. Al-Nakdy**

6. Where possible, the foundation should be planned in such a manner as to permit a subsequent alteration of natural frequency by changing the base area or mass of the foundation as may subsequently be found necessary (Arora, 1997).
7. The ground-water level should be as low as possible, and it should be at least deeper by one-fourth of the width of foundation below the base plane (Arora, 1997).
8. Machine foundations should be separated from adjacent building components by means of expansion joints. Machine foundation should be taken to a level lower than the level of the foundations of adjacent buildings, so that the wave transmitted through soil will not cause damage to the adjacent foundation (Arora, 1997).

Deng et al. (2007) presented the results of a three dimensional seismic analysis of a battered pile group design for a heavy machine foundation located in a seismically active region. Results of the analysis showed that the battered piles tend to attract significantly larger seismic loads in terms of the axial loads when compared with the vertical piles and require a careful attention for design of the pile connection to the pile caps. This result is a quantitative confirmation of the commonly known field performance problem. Further study of the results indicated that the main cause of the increase in axial loads in battered piles is the kinematic interaction between the soil layers and that of the pile group.

Fleischer and Trombik, (2008) explained that for all foundation types, the substructure (piles, soil, columns and springs) can be modeled by spring elements, the dynamic behavior can be represented accurately. Since today, enough computational calculating capacity is normally present in the design offices, it is recommended for table mounted foundations to include the whole structure and replace the soil/piles by spring elements. The material of the foundation stays (has to stay) mostly within the linear range. All machine anchorages have to be designed to withstand the full earthquake loads. This means that the global ductility has to be set to a low value, and the focus on constructive measures for increasing the plastic bearing capacity, if required, has to be laid on pile heads and column connections. Substructure of spring mounted foundation has to be stiff enough to avoid interaction of the fundamental eigen frequencies of the mounted machine foundation and the substructure.

## **2 MACHINE FOUNDATIONS RESTING ON PILES**

Utilization of piling in machine foundations is shown to provide more flexibility to the designer and quite possibly result in more economical design for some cases. It can also provide a solution to some difficult foundation problems. The key for useful utilization is a complete analysis method which provides for a choice of practical models.

ANSYS software provides an efficient tool for dynamic analysis and structural design of the machine foundation. This paper covers the results of study on the pile machine foundation. Analyses are carried out by studying the effect of various factors of loading, vertical displacement and vertical stress in the pile machine foundation cap are presented. The chosen factors are related to the geometry of the pile machine foundation (cap thickness and length), the geometry of piles (piles diameter and spacing between piles), and the increase in the dynamic load. The analysis was performed using (ANSYS) program.

## **3 DESCRIPTION OF THE PILED MACHINE FOUNDATION PROBLEM**

In the finite element solution, circular cross section of piles is adopted, the soil is meshed with the 8-node brick elements, Figure 1 presents the piled machine foundation with the location of the applied load, and Figure 2 which presents the meshed model of the piled machine foundation and soil. The lateral boundaries of the soil are chosen to be far enough from the zone of influence under the vertical load (five times the width of the pile cap). End bearing piles are taken into account with specified damping ratio. A lower boundary which simulates the depth of the soil layer, is also kept far enough from the pile bottom ( $0.25L$ , where  $L$  is the pile length) as the piles are assumed to be floated piles (i.e., the piles are not driven to a rigid stratum). Even the vertical displacement at the lateral and vertical boundary is zero; a boundary condition prescribing the vertical displacement with a value of zero is adopted. The horizontal displacement at the horizontal boundary is zero, while the vertical is not for the pile tips. The analysis process is considered at the top central point of the pile cap (node A) at which the vertical dynamic load is applied. Interface elements (contact surfaces) are used between concrete of the pile and its cap and the soil.

The analysis of pile machine foundation is performed for foundation resting on finite isotropic elastic homogenous soil as the machines may cause only small amplitudes of vibrations (Ottavini, 1975 and Liu and Novak, 1991). The concrete is considered linearly elastic also (Liu and Novak, 1991, Fleisher and Trombik, 2008). The value of Poisson's ratio for most types of soils can be found in Bowles (1997), and values for the static stress-strain modulus,  $E_s$ , for selected soils can be also assumed based on the guides of Bowles (1997).

**Mohammed Y. Fattah, Mohammed J. Hamood, and Ibtihal A. M. Al-Nakdy**

The soil used in this study is sandy clay. Hence, a typical range of values of :

The modulus of elasticity for sandy soil are considered:  $E_s = (25-250)$  MPa.

The Poisson's ratio range for sandy soil is  $(0.2 - 0.3)$ .

Three values for amplitude were taken in the analysis; 80 kN, 100 kN and 120 kN.

The harmonic forces in any direction perpendicular to longitudinal rotation axis are:

$$F(t) = P \sin(\omega t) \quad (1)$$

where:

$$P = m_i e \omega^2$$

$m_i$  = proportional part of rotating mass,

$e$  = mass eccentricity,

$t$  = time,

$\omega = 2\pi f$  = circular operating frequency of the machine, and

$f$  = operating frequency.the first page of these Instructions).

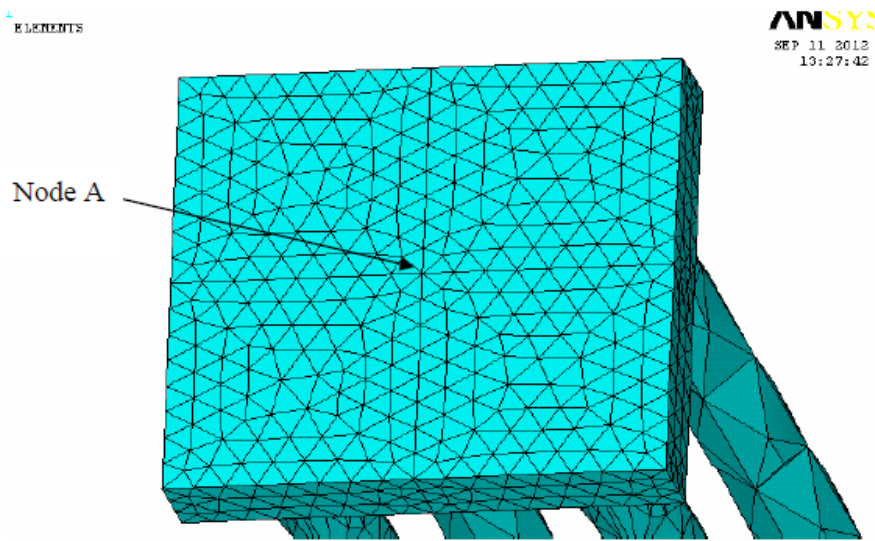

Fig 1: Finite element of pile machine foundation, which illustrates the location of the applied load.

Nine cases of pile machine foundation with dimensions shown in table (4.1) are chosen for analysis.

case	B (m)	W (m)	h (m)	d (m)	L (m)	$S_{c/c}$ (m)
1	2.5	2.5	0.5	0.5	20	1.5
2	2.5	2.5	0.75	0.5	20	1.5
3	2.5	2.5	1.0	0.5	20	1.5
4	2.5	2.5	0.5	0.8	20	1.5
5	2.5	2.5	0.5	1.0	20	1.5
6	2.5	2.5	0.5	0.5	20	1.25
7	2.5	2.5	0.5	0.5	20	1.75
8	3.75	2.5	0.5	0.5	20	1.5
9	5	2.5	0.5	0.5	20	1.5

Table 1: Parameters for the end bearing pile machine foundation.

where:

B = length of pile cap,

W = width of pile cap,

Mohammed Y. Fattah, Mohammed J. Hamood, and Ibtihal A. M. Al-Nakdy

$h$  = thickness of pile cap,  
 $d$  = diameter of pile,  
 $L$  = length of pile,  
 $S_{c/c}$  = spacing between piles, center to center, and  
 $P$  = amplitude of harmonic dynamic load.

Figure 2 presents the details of pile machine foundation adopted in this study, and Figure 3 presents the top view of the pile cap with different pile cap lengths. The material properties are given in Table 2.

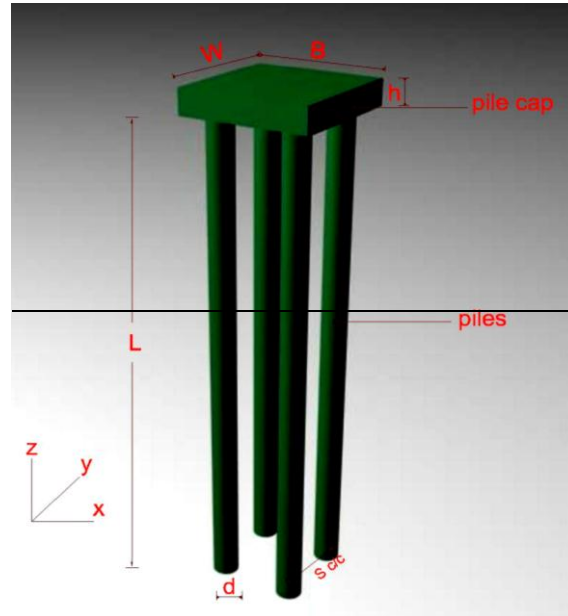

Fig 2: Details of pile machine foundation.

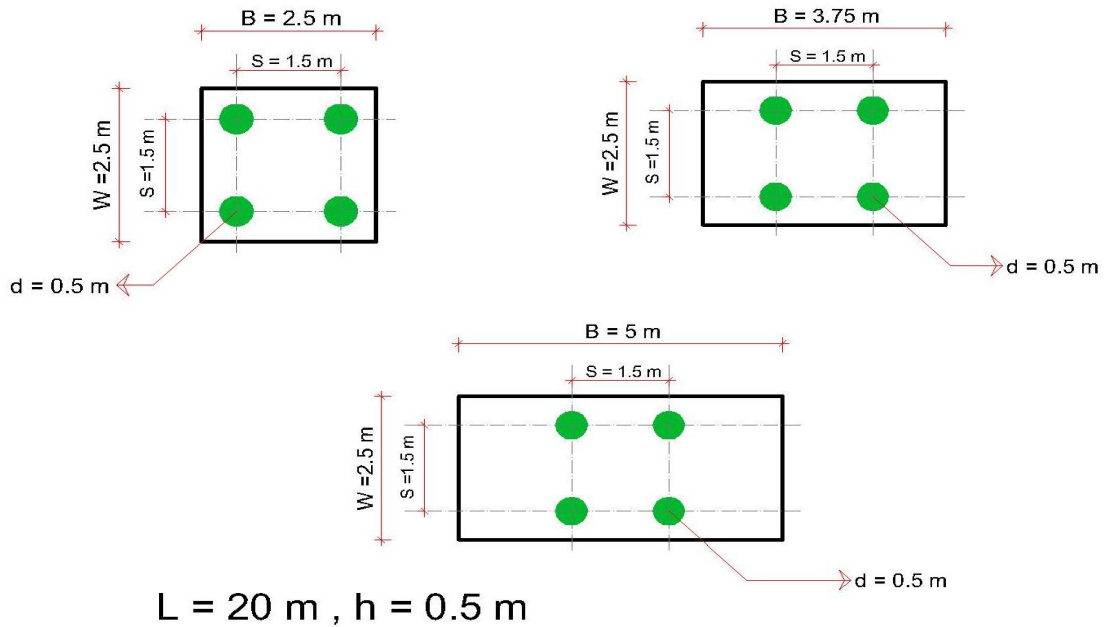

Fig. 3: Top view of pile cap with different cap lengths.

#### 4 EFFECT OF SPACING ON VERTICAL DISPLACEMENT AND FREQUENCY RATIO OF PILE MACHINE FOUNDATION

In order to study the effect of spacing between piles on the response of pile machine foundation, different values of pile spacing were studied.

In Table 3, values for different spacings are considered, and the relation between the maximum displacements and spacing is shown in Figure 4. The figure reveals that the maximum displacement is found to be at minimum value at spacing of 1.5 m and increases in the case of 1.25 m spacing by about 62% but it increases about 317% for the 1.75 m spacing and also by about 625% for the 3 m spacing than the 1.5 m spacing.

	Name	Definition	Values	
Concrete	E	Young's modulus (MPa)	$4700\sqrt{f'c}$	25742.96
	$\gamma_c$	Density of concrete (kg/m <sup>3</sup> )	2400	2400
	$\nu$	Poisson's ratio	0.15*	0.15
	$\beta_o$	Open shear transfer coef	0.2*	0.2
	$\beta_c$	Closed shear transfer coef	0.7*	0.7
	$f_t$	Uniaxial Cracking stress (MPa)	$0.62\sqrt{f'c}$	3.3958
	$f'_c$	Uniaxial Crushing stress (MPa)	$f'_c$ *	30.000
	$f_{cb}$	Ultimate biaxial compressive strength (MPa)	$1.2f'_c$	36.000
	$\sigma_h^a$	Hydrostatic stress	$1.157f'_c$	34.710
	$f_1$	Ultimate compressive strength for a state of biaxial compression superimposed on ( $\sigma_h^a$ ) (MPa)	$1.45f'_c$	43.500
	$f_2$	Ultimate compressive strength for a state of uniaxial compression superimposed on ( $\sigma_h^a$ ) (MPa)	$1.725f'_c$	51.750
Interface	$\mu$	Coefficient of friction	0.5*	0.5
Soil	$E_s$	Young's modulus (MPa)	30000*	30.000
	$\gamma_s$	Density of soil (kg/m <sup>3</sup> )	1800*	1800
	$\nu$	Poisson's ratio	0.3*	0.3
Steel	$\rho_{st}$	Steel ratio	0.002*	0.002

\* Assumed values.

Table 2: Material properties.

case	B (m)	W (m)	h (m)	d (m)	S (m)
1	2.5	2.5	0.5	0.5	1.25
2	2.5	2.5	0.5	0.5	1.5
3	2.5	2.5	0.5	0.5	1.75
4	5	2.5	0.5	0.5	3

Table 3: Parameters for the pile machine foundations.

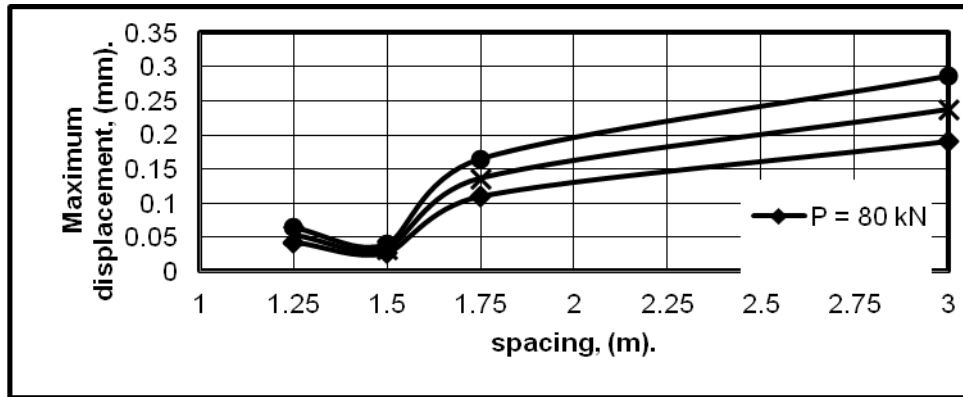

Fig. 4: Relation between the maximum displacement and spacing between piles.

Figure 5 shows the relation between the frequency ratio and maximum displacement for the four different spacings stated in Table 3. The maximum displacement is found to be minimum at frequency ratio for 1.5 m spacing at operating frequency of 60 rad/sec and natural frequency of 52.7 rad/sec. The frequency ratio decreases with increase of spacing values due to increase in natural frequency, except in the case of 3 m spacing where it increases due to decrease in natural frequency as the mass was increased obviously.

Frequency ratio is found to increase by about 5% for 1.25 m spacing than that of 1.5 m spacing and to decrease by about 3% for the 1.75 m spacing than that of 1.5 m spacing and increase by 40% for the 3 m spacing than that for 1.5 m spacing due to increase in mass that reduces the natural frequency and consequently increases the frequency ratio.

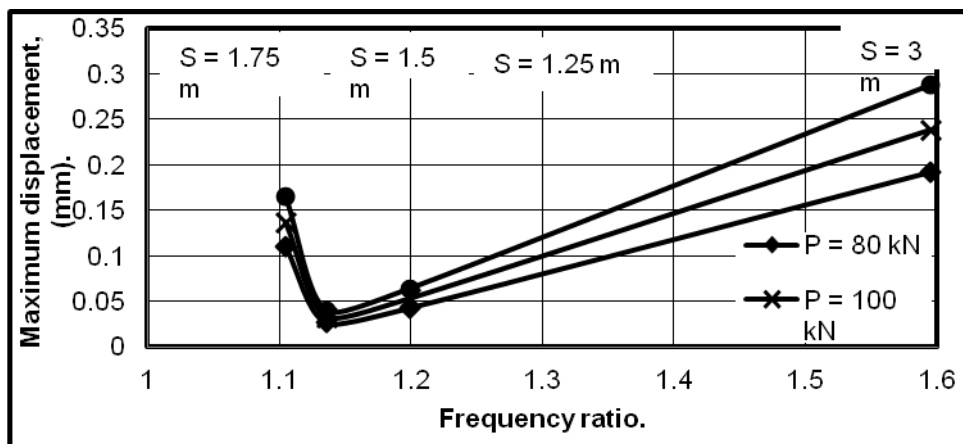

Fig 5: Relation between maximum displacements and frequency ratio for four different spacing.

## 5 COMPARISON BETWEEN PILE AND UNPILED MACHINE FOUNDATIONS

Introducing piles alters the displacement of pile cap obviously. With depth of soil 20 m below the (raft) cap without introducing piles with the other properties remain the same; a contact surface is created between the raft and the soil. Figures 6 and 7 show the response in the case of (2.5 m\*2.5 m) cap raft with thickness of 0.5 m. It is found that the maximum displacement decreases with the use of piles by about 65% under the three amplitudes (80 kN, 100 kN, 120 kN). The maximum displacement for the unpiled cap is found at frequency of (36 rad/sec). Figures 8 and 9 illustrate the relation between the maximum displacements with frequency for the case of (3.75 m\*2.5 m) unpiled cap with 0.5 m thickness. The maximum displacement is found to decrease without introducing piles by about 91% for the three amplitudes of dynamic load. The maximum displacement for the unpiled raft is at frequency of 12 rad/sec.

For the case of (5 m\*2.5 m) unpiled cap with 0.5 m thickness, Figures 10 and 11 show that the maximum displacement decreases with the use of piles by about 65%. The maximum displacement for the unpiled raft is found at frequency of 24 rad/sec.

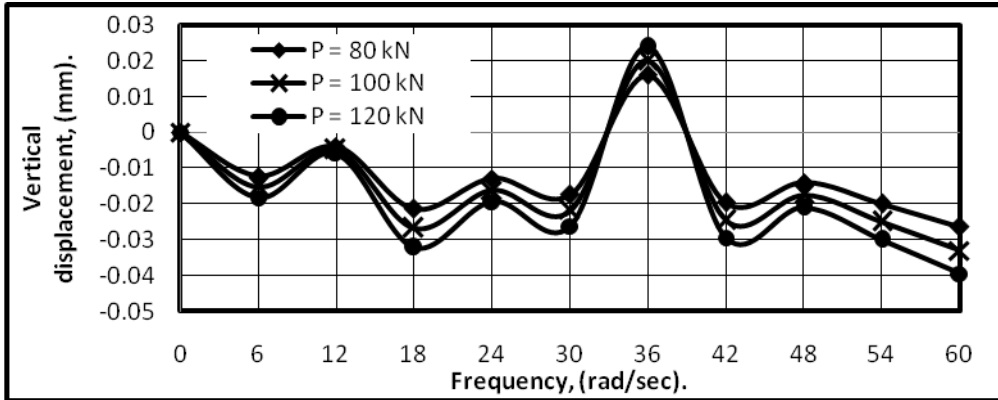

Fig. 6: Variation of vertical displacement with frequency of load for the pile machine foundation ( $h = 0.5$  m,  $d = 0.5$  m,  $B*W = 2.5$  m\* $2.5$  m,  $L = 20$  m,  $S = 1.5$  m) due to vertical dynamic load.

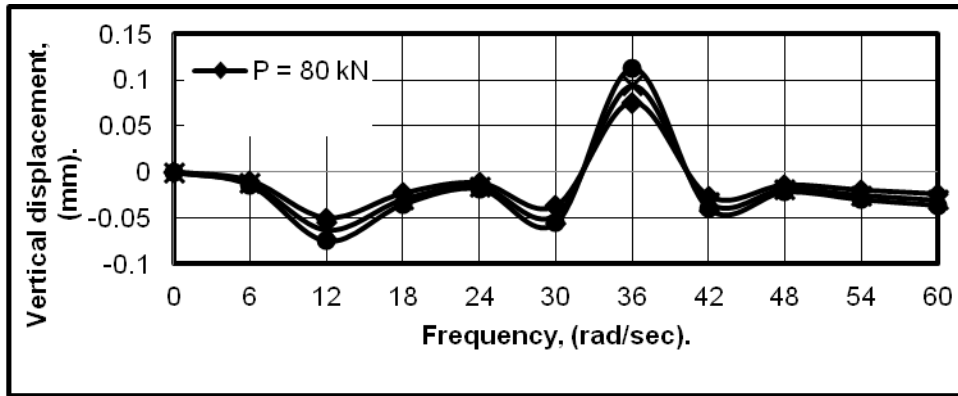

Fig. 7: Variation of vertical displacement with frequency of load for the unpiled machine foundation ( $h = 0.5$  m,  $d = 0.5$  m,  $B*W = 2.5$  m\* $2.5$  m,  $S = 1.5$  m) due to vertical dynamic load.

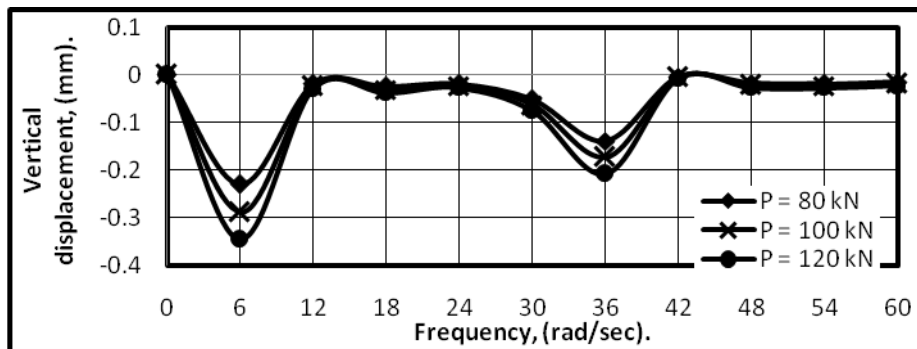

Fig. 8: Variation of vertical displacement with frequency of load for the pile machine foundation ( $h = 0.5$  m,  $d = 0.5$  m,  $B*W = 3.75$  m\* $2.5$  m,  $L = 20$  m,  $S = 1.5$  m) due to vertical dynamic load.

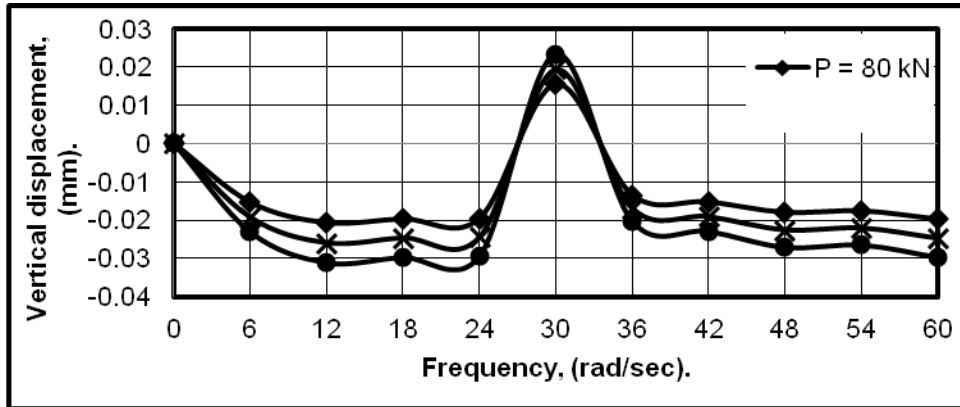

Fig. 9: Variation of vertical displacement with frequency of load for the unpiled machine foundation ( $h = 0.5$  m,  $d = 0.5$  m,  $B*W = 3.75$  m\* $2.5$  m,  $S = 1.5$  m) due to vertical dynamic load.

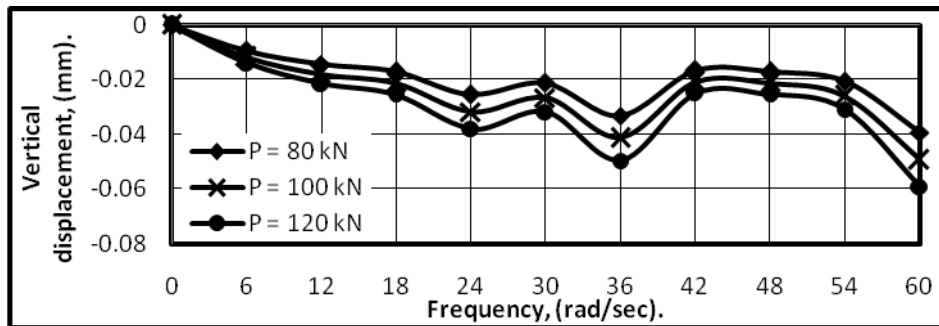

Fig. 10: Variation of vertical displacement with frequency of load for the pile machine foundation ( $h = 0.5$  m,  $d = 0.5$  m,  $B*W = 5$  m\* $2.5$  m,  $L = 20$  m,  $S = 1.5$  m) due to vertical dynamic load.

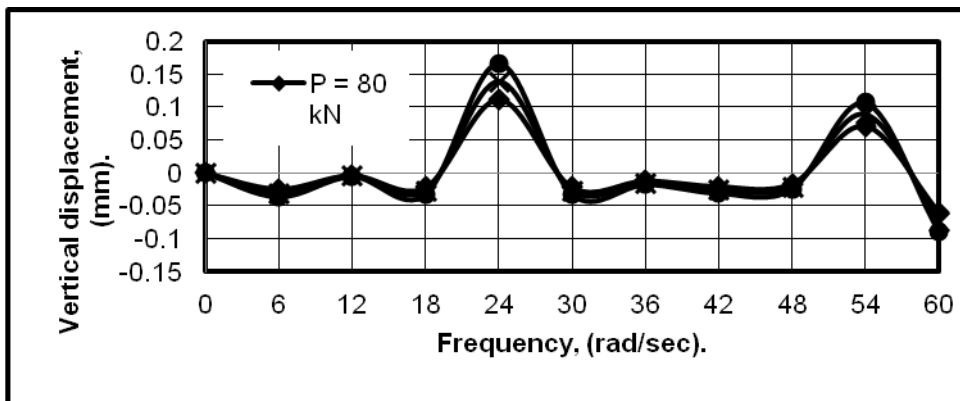

Fig. 11: Variation of vertical displacement with frequency of load for the unpiled machine foundation ( $h = 0.5$  m,  $d = 0.5$  m,  $B*W = 5$  m\* $2.5$  m,  $S = 1.5$  m) due to vertical dynamic load.

## 6 CONCLUSIONS

1. The frequency ratio decreases with increase of spacing values due to increase in natural frequency, except in the case of 3 m spacing where it increases due to decrease in natural frequency as the mass was increased obviously.
2. The increase in spacing caused the increase of natural frequency by about 6% in the case of 1.5 m spacing more than the 1.25 m case and by about 3% for the 1.75 m spacing more than the (1.5 m) reference case.



**Mohammed Y. Fattah, Mohammed J. Hamood, and Ibtihal A. M. Al-Nakdy**

3. The increase in pile cap length caused the natural frequency to decrease by about 18% for the 3.75 m pile cap length as compared with the reference case and by 29% in the case of 5 m less than the reference case. In the case of increasing pile cap thickness, there was only a slight difference in the values of natural frequency.
4. The maximum displacement is found to be at minimum value at spacing of 1.5 m and increases in the case of 1.25 m spacing by about 62% but it increases about 317% for the 1.75 m spacing and also by about 625% for the 3 m spacing than the 1.5 m spacing.
5. Frequency ratio is found to increase by about 5% for 1.25 m spacing than that of 1.5 m spacing and to decrease by about 3% for the 1.75 m spacing than that of 1.5 m spacing and increase by 40% for the 3 m spacing than that for 1.5 m spacing due to increase in mass that reduces the natural frequency and consequently increases the frequency ratio.

## **7 REFERENCES**

1. Arora, K. R., (1997), "Soil Mechanics and Foundation Engineering", 4th ed., Delhi Standard Publishers Distributors, India.
2. Bowles, J. E., (1997), "Foundation Analysis and Design", Fifth Edition, Engineering Computer Software, Peoria, Illinois.
3. Deng, N., Kulesza, R. and Ostadan, F., (2007), "Seismic Soil- Pile Group Interaction Analysis of a Battered Pile Group", 4th International Conference on Earthquake, Geotechnical Engineering, June 25-28, Greece 2007, paper No. 1733.
4. Fleischer, P.St. and Trombik P.G. (2008), "Turbogenerator Machine Foundations Subjected to Earthquake Loading", The 14 th World Conference on Earthquake Engineering, Beijing, China.
5. Liu, W. and Novak. M., (1991)," Soil Pile Cap Static Interaction Analysis by Finite and Infinite Elements", Canadian Geotechnical Journal, Vol.28, p.p. 771-783.
6. Prakash, S. and Puri, V.K., (2006), "Foundation for Vibrating Machines", Special Issue, April-May 2006, Journal of Structural Engineering, SERC, Madras, India, <http://yoga10.org/Documents/SPVKPSERCpaper.pdf>.
7. Rao, K., N. S. V., (2011), "Foundation Design Theory and Practice", a book, university Malaysia Sabah, Malaysia.