

FLR

Varian Cary Eclipse Fluorescence Spectrophotometer



NOTICE: This document contains references to Varian. Please note that Varian, Inc. is now part of Agilent Technologies. For more information, go to www.agilent.com/chem.



Cary Eclipse Fluorescence Spectrophotometer

Who is Varian?

Varian, Inc. has been supplying essential tools for scientists engaged in drug discovery, life science, genetic engineering, neuroscience studies, health care, environmental analysis, industrial R&D and quality control, and academic applications for over 50 years. Our range of UV-Visible-NIR spectrophotometers, fluorescence spectrophotometers, NMR spectrometers, NMR imaging spectrometers, gas chromatographs, gas chromatograph/mass spectrometers, high-performance liquid chromatographs, atomic absorption spectrometers and inductively coupled plasma spectrometers are supported by extensive consumable supplies and services that will keep your laboratory running efficiently. We are a global organization with offices or dealers in over 70 countries.

How does Cary fit in?

The Cary name has been associated with high performance spectrophotometers for over 50 years. From the Cary 11 introduced in 1947 to the Cary 50, 100, 300, 400, 500 families introduced in 1997, the name Cary has been synonymous with excellence and performance. Cary instruments have become the standard for researchers wanting to push the limits of their measurement techniques. Cary instruments have also found a home in many of the routine laboratories around the world where their reliability and ease-of-use are vital. The Cary Eclipse fluorescence spectrophotometer fits well within the Cary range, offering the excellent specifications and modern software that has become the Cary standard.





What's inside?

The Cary Eclipse fluorescence spectrophotometer was designed from the ground up, incorporating the latest optical and electronic technology. Included as standard are features such as corrected spectra, excitation and emission filters and extended range PMT detectors, so there won't be any nasty budget surprises.

Optional accessories such as the peltier thermostatted multicell holder and the microplate reader extend the capabilities of the instrument. With the flick of your wrist you can convert from using a standard cuvette to measuring a 384 well microplate.

Excellent sensitivity is a result of using an intense Xenon flash lamp, coupled with optimized grating blaze angles and coatings which ensure sensitivity across the whole wavelength range. Photosensitive samples are not exposed to continuous light as the Xenon flash lamp flashes only to acquire a data point.

Reduced volume cuvettes (40 μ L and 400 μ L) are available. The horizontal beam profile ensures excellent sensitivity even with such low volumes.

The large sample compartment makes it easy to install and remove accessories. You have plenty of room to fit your own research apparatus. We can even provide a baseplate for you to build upon.

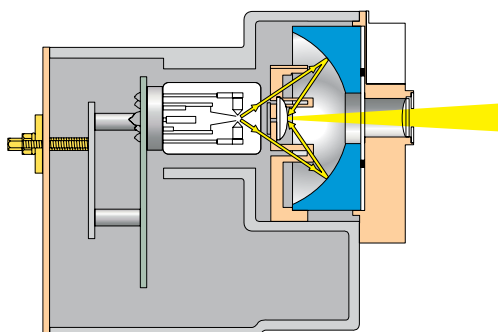

The Schwarzschild collection optics capture a large portion of the light from the powerful Xenon flash lamp and direct it through the sample. This results in excellent sensitivity and low signal noise.

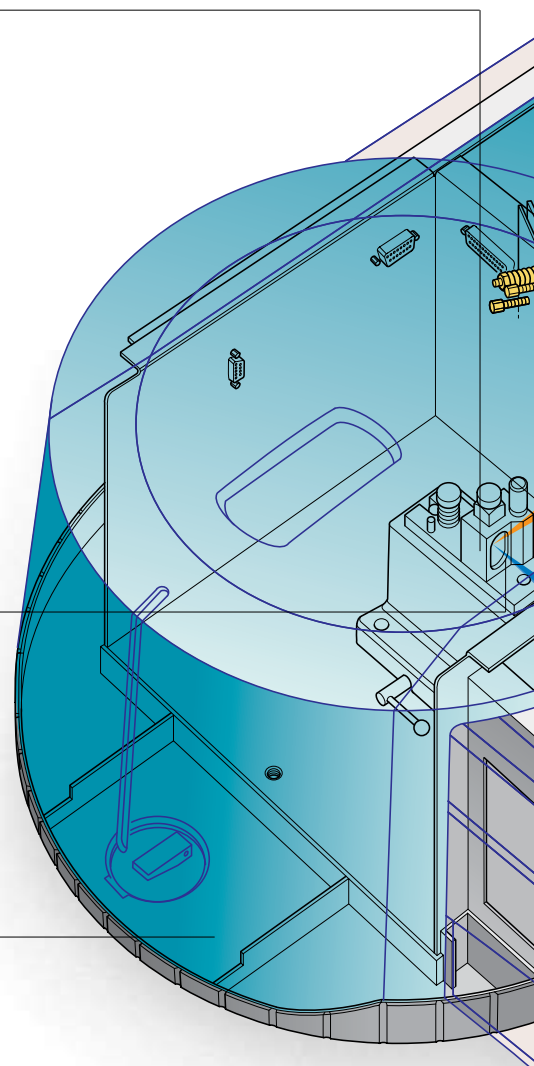

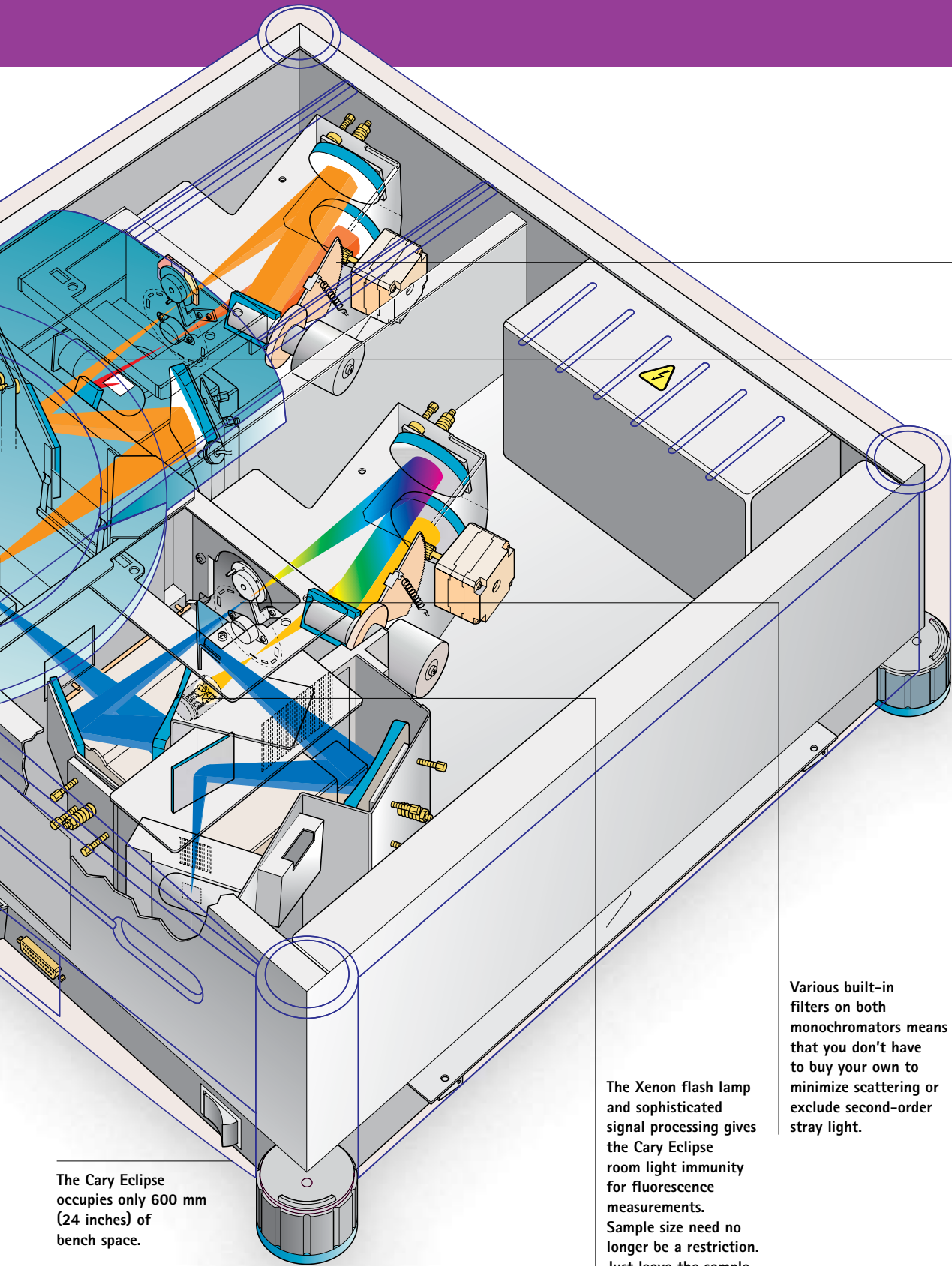

Scan fast—the whole wavelength range in less than 3 seconds.

Red-sensitive Photomultiplier tube detectors extend sensitivity up to 900 nm without sacrificing UV performance.

Various built-in filters on both monochromators means that you don't have to buy your own to minimize scattering or exclude second-order stray light.

The Xenon flash lamp and sophisticated signal processing gives the Cary Eclipse room light immunity for fluorescence measurements. Sample size need no longer be a restriction. Just leave the sample compartment open whilst collecting data!

The Cary Eclipse occupies only 600 mm (24 inches) of bench space.

Cary Eclipse Software— something for everyone

Single window operation: All controls can be accessed from this window, making operation quick and easy.

Having trouble figuring out what a particular button or control does? Just hold the mouse pointer over the object until the hint text pops up with an explanation.

Power-users can use the built-in spectroscopy language, the Applications Development Language (ADL), to automate your laboratory's measurements. Not-so-power-users can download these highly customized methods from Varian's website www.varianinc.com

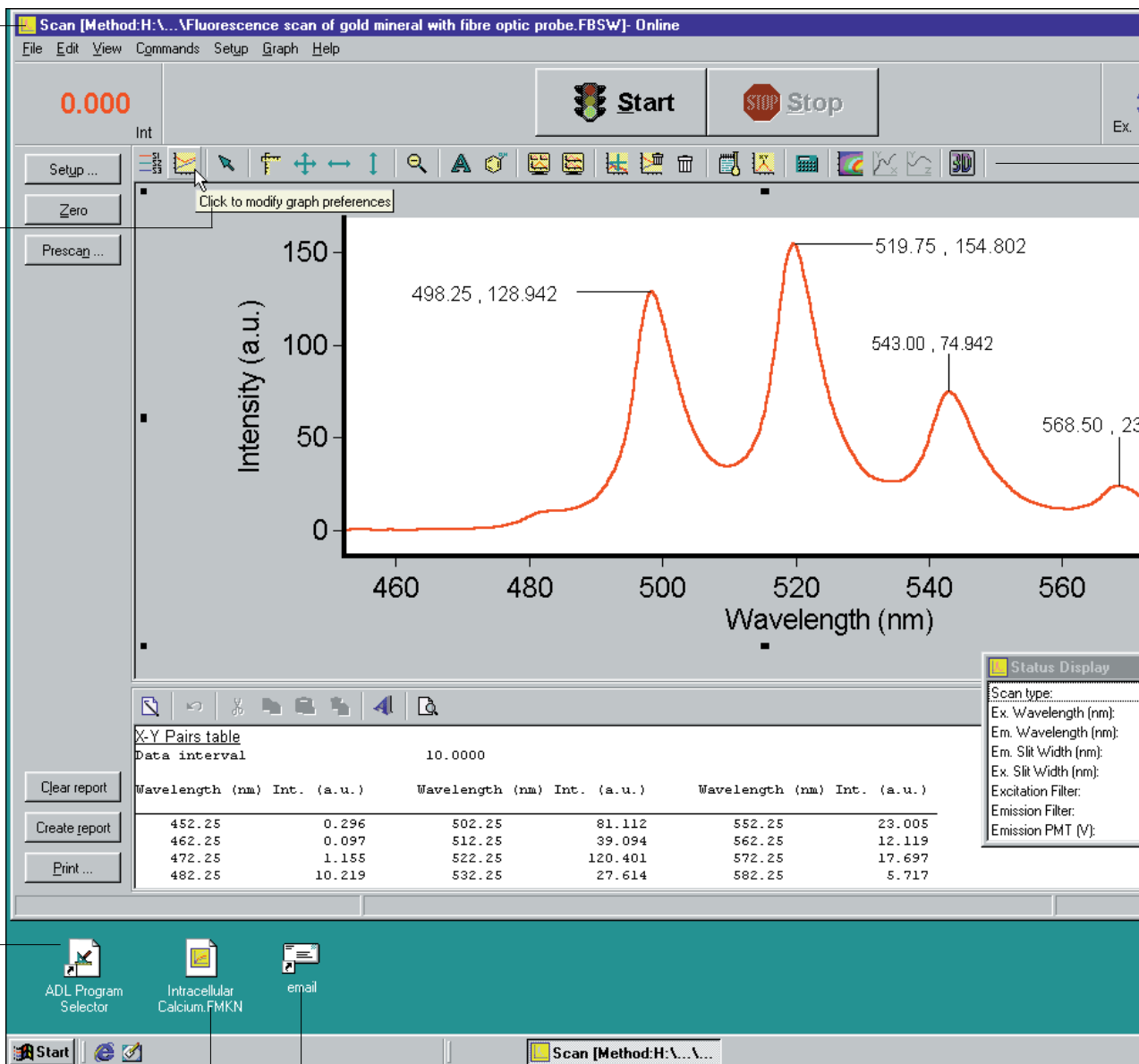

Create an icon for your common measurements. A double-click on the icon loads the appropriate application and method.

The Cary Eclipse can email you when the data collection is finished—with or without the data file attached.

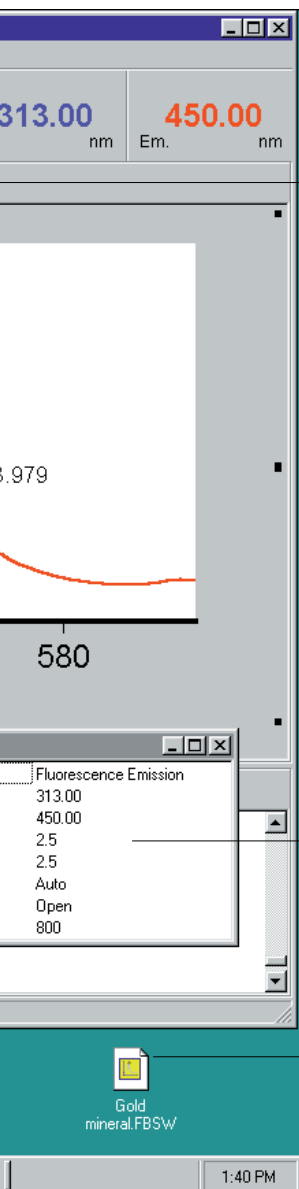

The Cary Eclipse software features toolbars to give you quick access to the most common graphics and report operations, including: zooming, cursor, adding text, changing axis ranges, drawing contours, and previewing reports.

Status display shows you the current instrument parameters at a glance.

You can store all method and report parameters, calculations and graphical displays in one file. This saves time as you simply recall one file instead of several.

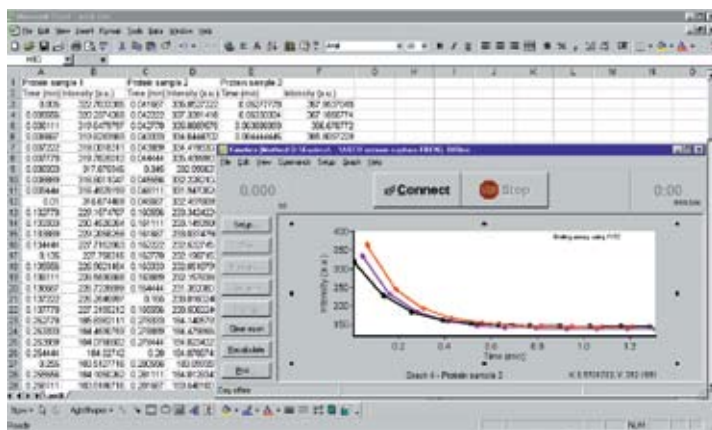

Data can be automatically exported to a spreadsheet at the end of the measurement.

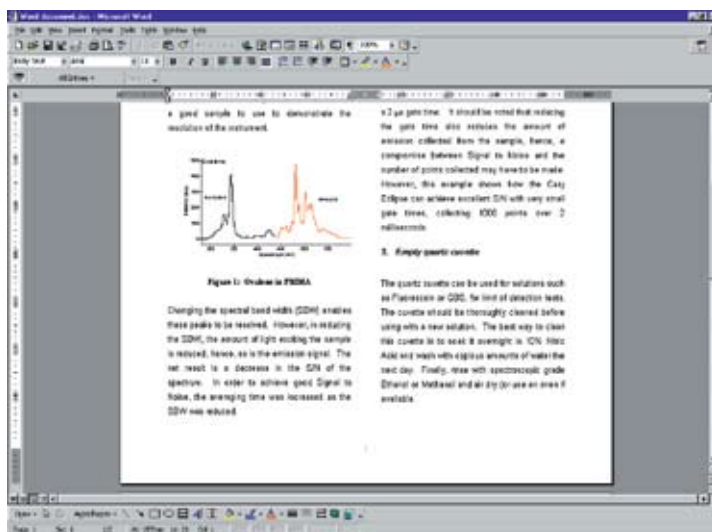

Prepare to publish! You can cut and paste graphs from the Cary Eclipse software into any word processing package, including any bitmaps or text you may have added to the graph.

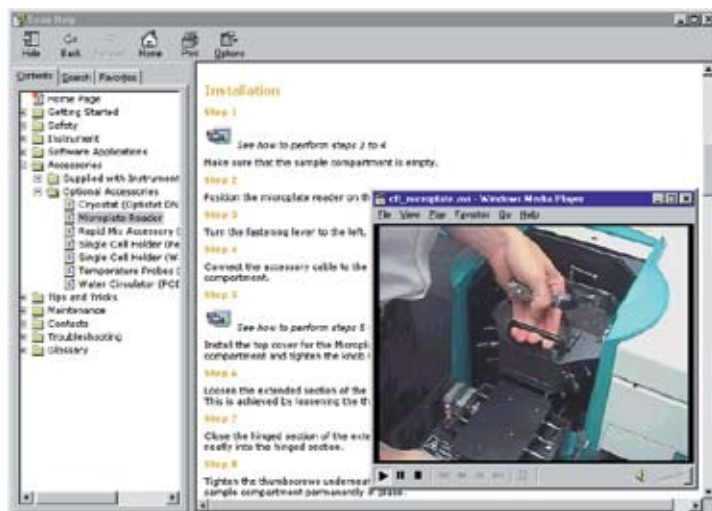

The Cary Eclipse software includes step-by-step video clips for hardware installation and use.

Cary Eclipse Software—Scan



Three different packages of the Cary Eclipse software are available: Scan, Bio and Conc. The Cary Eclipse software is designed in modules, each meeting a different analytical requirement. For example, the Scan module only does wavelength scanning and the kinetics module presents the user with controls appropriate only for time-based data collection. This modular approach reduces training time as only the options appropriate for that type of analysis are presented to the user, instead of a bewildering array of menus and selections. The Scan package contains the following modules: Scan, Simple Reads, Advanced Reads, Align, GLP Admin, Validate, System information and ADL Shell (for more information about each of these modules, refer to the Cary Eclipse specifications brochure).

The Scan package has a host of special features that will allow you to get the maximum information from your samples:

- Signal-to-noise mode is a unique method of collecting data that allows you to control the level of precision you want across the whole scan. The instrument will scan quickly in areas of high emission and slow down in areas where the emission is less.
- CAT scan mode: Not sure of what averaging time to use? Just average a number of individual scans until you are happy with the signal to noise resolution
- Corrected excitation and emission spectra up to 600 nm are provided at no additional cost. Corrected spectra up to 900 nm is optional. And you can also view the correction factors in ASCII format!



- The Cary Eclipse fluorescence spectrophotometer is able to scan at 24 000 nm/min without peak shifts due to the design of the monochromator drive mechanism. The grating is moved only when the lamp is off, resulting in a go-stop-flash method of taking a measurement. The wavelength does not change whilst a measurement is being taken.

Included in the wide range of Cary Eclipse accessories is a fibre optic system suitable for measuring the emission from the surface of a solid or that emitted by a liquid. With the unique feature of fluorescence room light immunity, the Cary Eclipse fibre optic system is the most sensitive remote reading solution available today. No restrictions means that measuring samples has never been easier, or more fun!

You can elect to scan in wavelength, wavenumber, angstroms or electron volts. The wavenumber option is linear—the instrument is driven so that the wavenumber (not the wavelength) interval is constant.

Obtain a 3-D graph or contour plot in seconds! Use the 3-D mode to automatically collect a series of excitation, emission or synchronous scans in all X modes. Just sit back and let the Eclipse do all the work!

Create an excitation/emission matrix (EEM) or 3-D plot to see exactly what is happening in your sample, e.g., what happens to the emission intensity as the excitation wavelength is changed? A 3-D plot shows you the interaction between emission wavelength, excitation wavelength and fluorescence intensity. The 3-D data can be sliced to produce single excitation or emission scans, or contour plots can be created to show the number of emitting species.

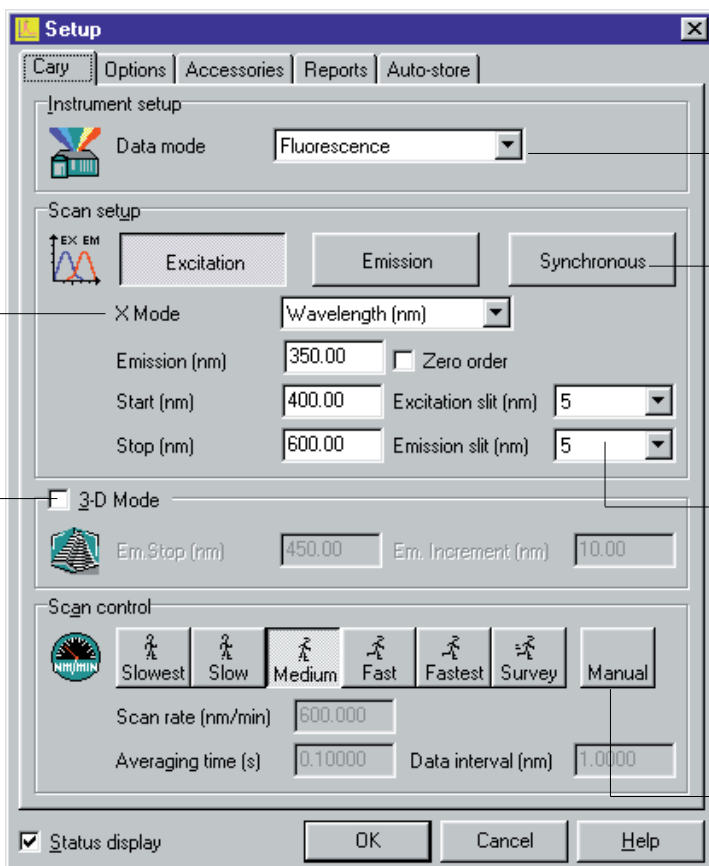

Three modes of operation are offered: fluorescence, phosphorescence and bio-/chemi-luminescence.

Perform synchronous scans with a constant wavelength or wavenumber difference between monochromators to resolve multi-component mixtures

Record fine structure information in spectra by using the minimum resolution of 1.5 nm. And for broad band solution spectra, 20 nm SBWs are available to achieve maximum sensitivity.

If you want precise control over how much signal averaging is done and how frequently data points are collected then you can choose to set both the Averaging time and the Data interval. If you would prefer that they be automatically set for you then just select how fast you want to scan. You can also elect to perform real-time smoothing of the data.

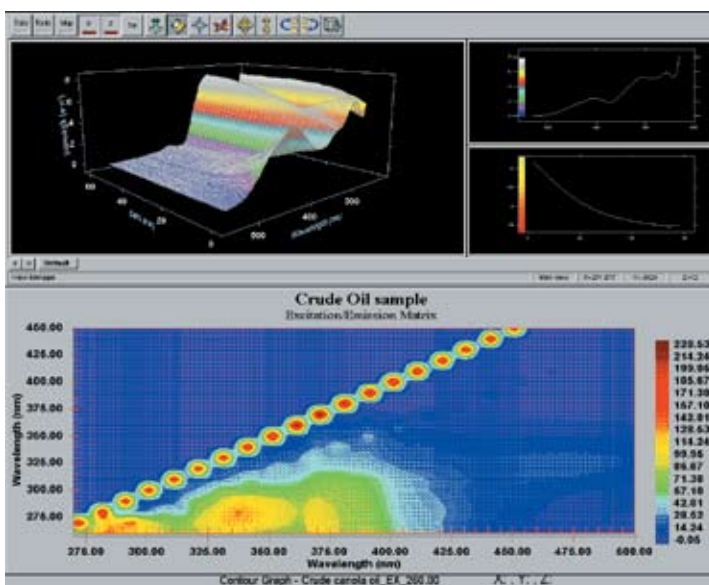



Cary Eclipse software—Bio

The Bio package contains the following modules: Kinetics, Lifetimes, Scan, Concentration, Simple Reads, Advanced Reads, Align, GLP Admin, Validate, System information and ADL Shell (for more information about each of these modules, refer to the Cary Eclipse specifications brochure).

The Cary Eclipse provides some unique capabilities, including:

Fast Kinetics

The Cary Eclipse's electronic design, coupled with the use of the Xenon flash lamp, allows steady-state fluorescence data to be collected at up to 80 points a second. Use the rapid mix accessory to analyze reactions that are over in less than 1-2 seconds.

Data security guaranteed

Some spectrophotometers only store data at the end of a run, so if the power fails during the analysis you have to start again. The Cary Eclipse software stores data as it is acquired, so even if someone accidentally pulls the power plug, you'll still have the data up to that point.

Can I vary the data collection rate?

If you have a reaction which starts off very fast and then slows you may want to collect data at different rates over the course of the reaction—fast at the start (up to 80 data points per second) and then slower during the later part of the reaction. You can specify multiple data collection rates for different time segments of the assay. The Kinetics software also caters for long, slow reactions with the ability to collect data for up to 20 000 minutes without the restriction of a limited number of data points in a file.

Need an extension?

If you decide during an assay that you set an incorrect end time, you can extend the length of the assay without stopping the measurement. You can also use the pause/continue function to add reagents without introducing spikes in your data by opening the sample compartment lid.

Why do 4 experiments when you can do 1?

The Dwell time option in the Kinetics software allows you to measure multiple data points per cell before moving to the next cell. Use the multicell holder to monitor four very fast reactions in the one experiment.

Intracellular ion concentrations

Intracellular ion concentration analysis or pH measurements are also possible with the Cary Eclipse. Using the fast slew rate of the monochromators, data can be acquired and displayed in real time within a second for ratiometric measurements or every 12.5 ms for single wavelength dyes.

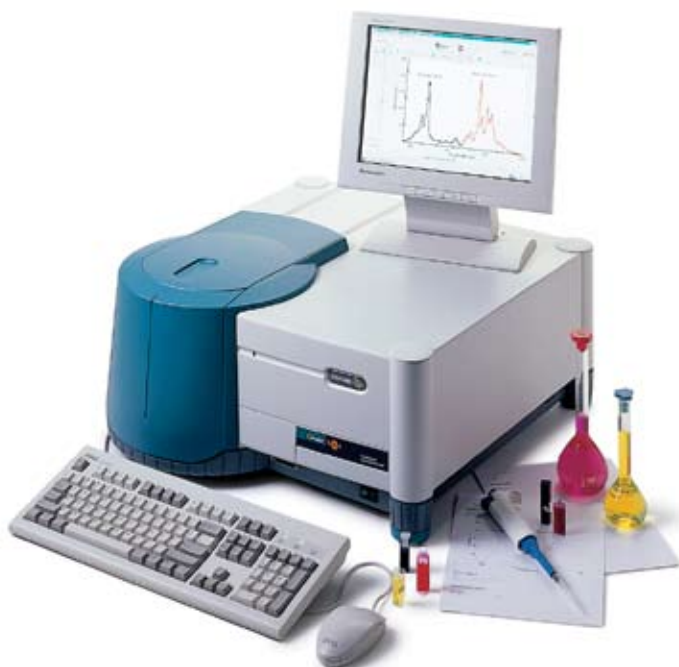

Rotational motion of molecules

The Cary Eclipse has available UV transmitting film polarizers allowing excitation down to 275 nm, so even tryptophan can be excited. The use of the flash lamp means that you do not have to worry about photobleaching. The polarizers are easily cleaned and maintained, thanks to their sturdy design. With an extremely low extinction ratio in the cross-position, rotational motion of proteins and solvent interactions can be measured with high precision and accuracy. The Cary Eclipse polarizers also allow measurements to be obtained at the magic angle of 55° as well as the complimentary angle of 35° .

Time-resolved measurements

Phosphorescence and delayed fluorescence lifetime measurements, e.g. Europium, are made easy using the Lifetimes application. Sophisticated data acquisition electronics coupled with the flash lamp allows data to be collected real time for gate times $> 50 \mu\text{s}$. And for decays that are even faster, a minimum gate time of $1 \mu\text{s}$ is also available. Low emitting samples are also measured with ease. To improve the Signal to Noise just average a series of individual decay curves or 'pump up the intensity' by increasing the number of flashes prior to data collection. Single or double exponential fitting procedures are also possible with the built-in data analysis algorithms.

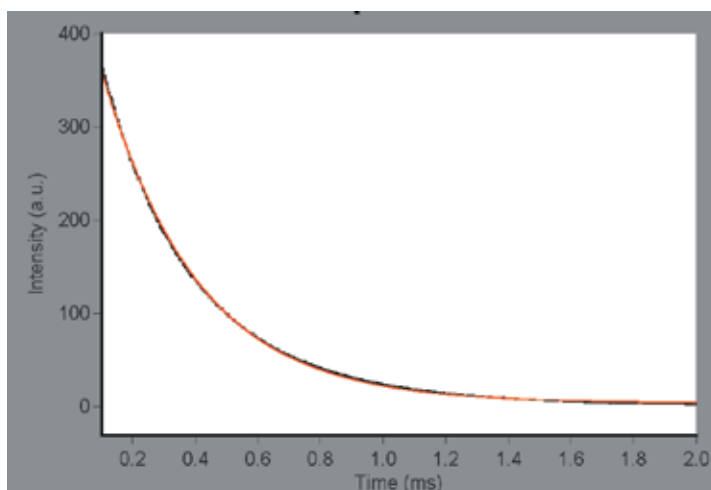

Perform time-resolved measurements with a $2 \mu\text{s}$ gate time! This example shows the time-resolved fluorescence decay of Europium (III) over a 2 ms time period. In being able to collect 1000 data points, rate calculations can be performed with a high precision and accuracy.

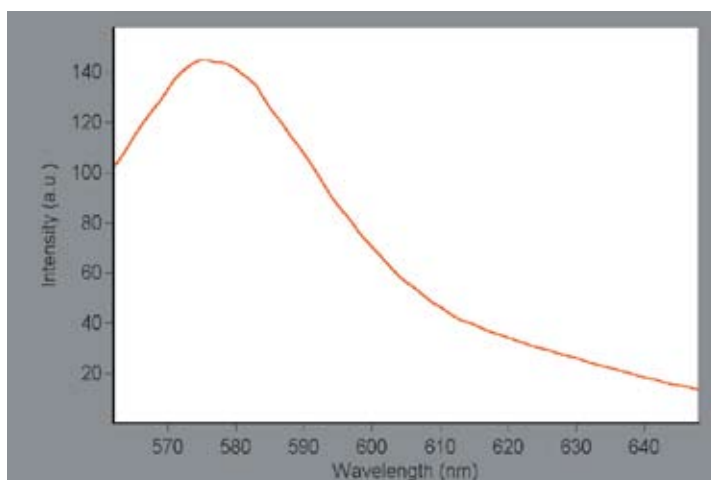

The microplate reader can easily scan cells adhered to the side of a well, with good signal to noise. This figure shows an emission scan of Rhodamine B which has been coated to the side and bottom of a 384 well white microplate.

**Measure and heat multiple samples
simultaneously**

The Cary Eclipse can be fitted with a peltier thermostatted multicell holder to allow the simultaneous measurement of up to four samples.

Stirring is smooth and easy to control

If your samples contain whole cells or particulate matter you will need to stir the solution during the measurement to ensure that the reactants are constantly mixed. The stirring mechanism of the Cary Eclipse thermostatted cell holders relies on a rotating magnetic field, generated by an alternating electric current. This ensures reliable operation with no fluctuations in stirring speed and allows complete control over the speed of the stirring. All 4 cells can be stirred at a constant rate for extended periods of time.

Excellent temperature control

The temperature in the multicell holder is electro-thermally controlled by peltiers. Peltiers are electrical heat pumps which transfer heat from one place to another and offer the rapid and precise temperature control which is essential for controlling the intensity of fluorescence emission. The temperature control of the peliter thermostatted cell holders is extremely stable over time, with a typical variation being ± 0.05 °C. The cell to cell variation is also minimal with a maximum difference of 0.2 °C at 37 °C.



The use of peltiers gives you complete control over temperature ramping for thermal denaturation and renaturation studies of DNA via Fluorescence Resonance Energy Transfer (FRET). The optional Temperature probe allows you to measure the temperature of the solution inside the cuvette. Depending upon the ambient conditions in your laboratory and the thermal conductivity of your cuvettes and the sample, there can be a significant temperature difference between the cell holder and the solution inside the cuvette.

Flick! Now I'm a microplate reader.

The easily-installed Microplate reader accessory turns the Cary Eclipse fluorescence spectrophotometer into a Microplate reader in less than 30 seconds. The system achieves high throughput with excellent sensitivity by using reflective optics instead of fibre optics to focus the light onto each well. Some of the microplate reader's exciting features include:

- Speed: measure 96 wells in less than 50 seconds and 384 in less than 90 seconds!
 - Full wavelength scanning: Unlike many dedicated microplate readers that require the use of the correct filter to match your fluorescence probe of interest, the Cary Eclipse can perform a full wavelength scan on each well within minutes. Microplate samples can be measured in steady-state fluorescence, phosphorescence, bio-/chemi-luminescence or time-resolved delayed fluorescence modes.
 - All of the Eclipse's measurement capabilities can be used with the microplate reader system. This includes continuous monitoring kinetics, single intensity readings or even average multiple readings per well and wavelength scanning. If you are a researcher wanting the ultimate flexibility then the built-in Cary Applications Development Language (ADL) will allow complete customization of the way you want to collect your data and report the results.
 - If you have a non-standard microplate or substrate then you can customize the measurement positions. The image spot size can be controlled using the spectral bandwidth selection with the smallest image size being 2 mm in diameter.
- 
- The optical design allows for measurements of minute sample quantities deposited on the sides or base of the wells.
 - The Auto-align feature in the software will align the excitation beam on your microplates automatically. The process takes about a minute and the information about each plate type is stored automatically.
 - The microplate reader can be used as an x-y transport if you want to measure samples other than microplates. Gels, films and solids can easily be measured at various locations on their surface.

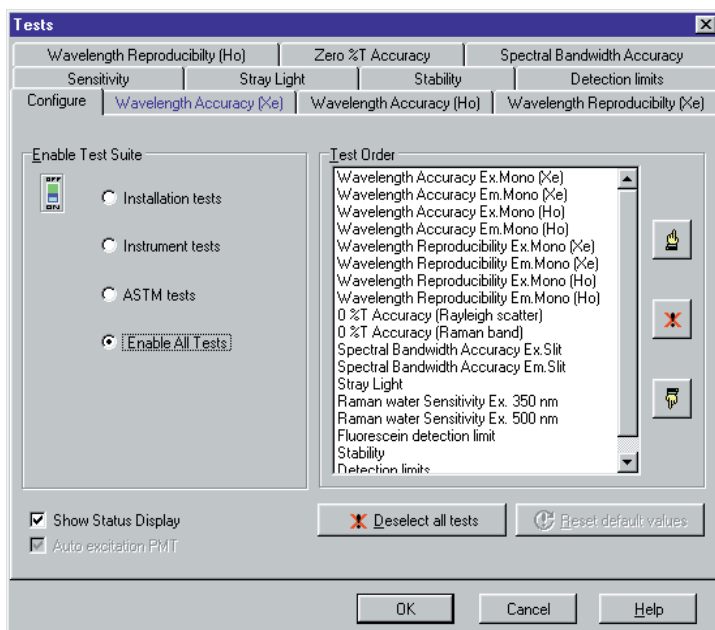

The Validate software makes it easy to test your instrument—just select the tests you want to do and walk away.

How do I know if my Cary Eclipse is working correctly?

The Cary Eclipse instruments are equipped with a range of tools to make checking your instrument's performance easy. Supplied with each package is the Instrument Validation application. This software automates the testing of the instrument hardware* and contains the most comprehensive suite of tests offered by any manufacturer today.

Can I get my instrument recertified?

At installation your instrument will be checked against specifications. As part of your ongoing validation program you may want to have your instrument recertified, to ensure that it is still meeting those specifications. Varian offers a recertification service which involves an on-site visit from a Varian Engineer who is equipped with various traceable standards and other test equipment. This means that you don't have to purchase and maintain expensive standard materials and if the instrument needs adjustment, the engineer will fix it for you.

What about GLP compliance?

The Cary Eclipse software is Good Laboratory Practise (GLP) compliant*. To make GLP compliance easier, the software offers a range of functions. For example, a desktop shortcut can be setup to startup an application and load a particular method. This means that if the laboratory routinely runs three different quantitative analyses, three icons can be setup on the desktop, one for each analysis. The operator then just clicks on the appropriate icon.

How do I get help if I have a problem?

Varian's global reach makes it easy for you to get answers for any problems you may have. You will have access to many resources including:

- Free access to other Cary Eclipse users around the world via an Internet mailing list. If you have access to Email then you can ask any question you like, e.g., Has anyone measured this type of sample before? Your email will be automatically sent to all other Cary Eclipse users who subscribe to the list. Experts at Varian also belong to this list, so you are assured of getting the answer you need. Varian also uses the mailing list to notify users of new products and application notes etc.
- You can call your Varian office and get over-the-phone support or request an on-site service call.
- Varian's web site contains many application notes and frequently asked questions. You can use these to find out how to measure a particular sample or how to optimize the use of your Cary Eclipse. A visit to the web site will also give you information on the latest software and hardware releases.
- If you need parts or supplies for your Cary Eclipse then our web site has an extensive list. If you aren't connected to the Internet then you can receive the information on CD ROM.

Safety

It is Varian's policy to manufacture safe products and to meet all legal requirements governing the design, manufacture and sale of safe products. As with all similar products, some or all of the following hazards may be present: high temperatures, high pressure gases, explosive gases, magnetic and radio frequency radiation, UV light and electricity. Each product is designed to protect operators from potential hazards. Varian supplies instructions which describe the correct procedures for the operation and maintenance of each product. The Cary Eclipse fluorescence spectrophotometer is designed to measure the emission of light from materials.

* For details refer to the separate Specifications brochure.

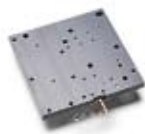

Accessory mounting base



Automated polarizer



Fibre optic coupler



Fluorescence test kits



Manual polarizer



Microplate reader



Mount for Oxford cryostat



PCB-150 peltier water bath



Peltier and water thermo multicell holders



Rapid Mix accessory



Single peltier cell holder



Single water thermo cell holder



Solid sample holder



Standard single cell holder with base



Temperature controller



Temperature probe

How easy is it to install and remove Cary Eclipse accessories?

Simple. Each accessory features a quick-release mechanism that fastens or releases the accessory from the sample compartment with a flick of your wrist. The plug-and-identify electronics allows the Cary Eclipse software to know which accessory is installed and tailor software options appropriately.

I have built my own accessories. Can I use them in a Cary Eclipse?

All accessories are centrally controlled by the Accessory Controller, built into the Cary Eclipse instruments. Instead of each accessory having their own electronics, the Accessory Controller provides the interface between the Cary software and the accessories. If your custom-built accessories will fit into a Cary, you can use the Accessory Controller to control them. Even external accessories, such as titrators, lasers and pH meters can be controlled.



Visit Varian at www.varianinc.com

**Varian Instrument Business
Manufacturing facilities**

Varian Optical Spectroscopy Instruments
Mulgrave, Victoria, Australia
Tel (3) 9560 7133 Fax (3) 9560 7950

Varian Chromatography Systems
Walnut Creek, California, USA
Tel (510) 939 2400 Fax (510) 945 2102

Varian NMR Instruments
Palo Alto, California, USA
Tel (650) 493 4000 Fax (650) 852 9688

Sample Preparation Products
Harbor City, California, USA
Tel (310) 539 6490 Fax (310) 539 4270

Vacuum Products
Lexington, Massachusetts, USA
Tel (617) 861 7200 Fax (617) 860 5437

Varian SpA
Leini (Torino) Italy
Tel (11) 997 9319 Fax (11) 997 9350

Specifications subject to change
without notice.

© Varian Australia Pty Ltd
ACN 004 559 540
Partnumber 85 101757 00
Australia 6/2006

®Word, Access, Excel and Windows are
registered trademarks of Microsoft Corp.
Telediagnosics®Varian

Sales offices

Australia
Varian Australia Pty Ltd
Mulgrave, Victoria
Tel 1 300 368 274

Austria
Varian Ges.m.b.H.
Vösendorf bei Wien
Tel (1) 69 99 669

Belgium
Varian Belgium NV/SA
Zaventem
Tel (0) 15 55 6460

Brazil
Varian
Indústria e Comércio
Sao Paulo
Tel (11) 820 0444

Canada
Varian Canada Inc.
Mississauga, Ontario
Tel 1 800 387 2216
or (905) 819 8181

Europe (other)
Varian International AG
Bergen op Zoom
Tel (0164) 282800

France
Varian S.A.
Les Ulis Cédex
Tel (1) 69 86 3838

Germany
Varian GmbH
Darmstadt
Tel (6151) 703 362

Italy
Varian SpA
Torino
Tel (11) 997 9111

Japan
Varian Japan Ltd
Tokyo
Tel (3) 52321239

Korea
Varian Technologies
Korea Ltd
Kangnam Gu,
Tel (2) 345 22452

Mexico
Varian S.A.
Mexico City,
Tel (5) 533 5985

Netherlands
Varian Nederland B.V.
Bergen op Zoom
Tel (0164) 282800

Russian Federation
Varian Associates Inc.
Moscow
Tel (095) 9374280

South America
Varian
Indústria e Comércio
Sao Paulo
Tel (11) 820 0444

Spain
Varian Ibérica S.L.
Madrid
Tel (91) 472 7612

Sweden
Varian AB
Solna
Tel (8) 445 1620

Switzerland
Varian International AG
Zug
Tel (41) 749 88 44

United Kingdom & Eire
Varian Ltd
Walton-on-Thames
Tel (0) 1932 898000

United States
Varian Associates
Walnut Creek
Tel 1 800 926 30 00 or
(925) 939 2400

Other countries
Varian Australia Pty Ltd,
Australia
Tel (3) 9560 71 33
Fax (3) 9560 79 50